

Standroid Setup Instructions

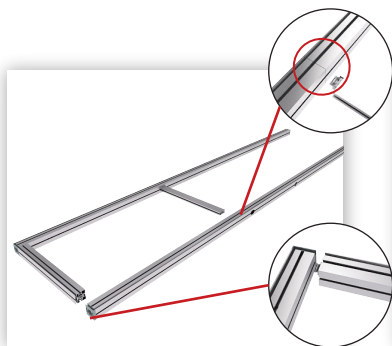

1. Assemble the bungie cord poles by pushing the shafts in the corded post.



2. Connect only one horizontal on the first joint, see picture.



3. Lift the frame and fit to the base, push it all the way in to the round plate.

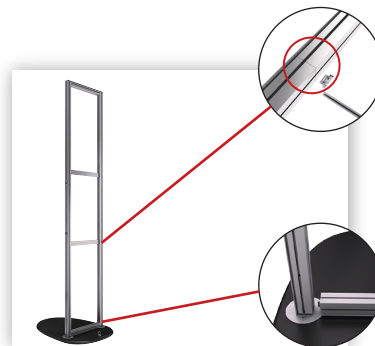

4. Force this last profile in place and lock both sides, it is made a little tight so it locks the frame.

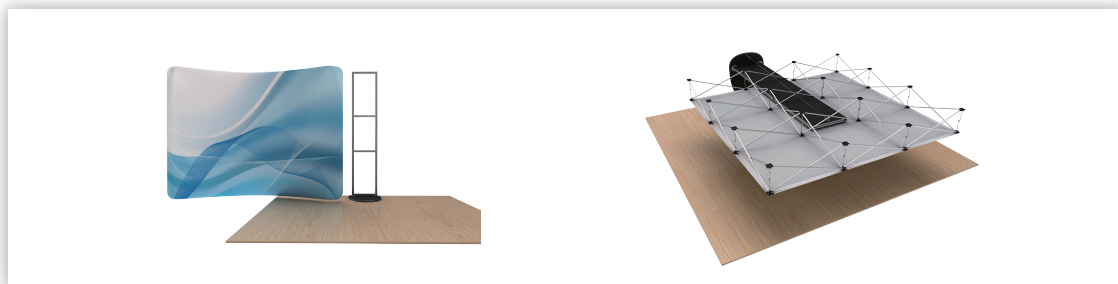

5. Assemble waveline frame and place in front of Standroid make sure in middle. After you assemble standroid ,lay horizantac and slide onefabric in position.

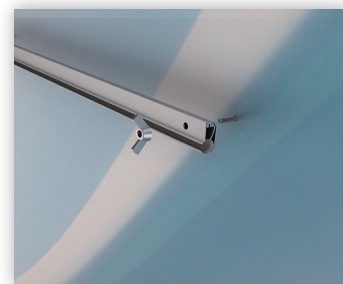

6. From the back insert the 2 bolts that secure the TV profile. There are 3 holes you can select the height you need, push the fabric against the screw and make a hole in the fabric.

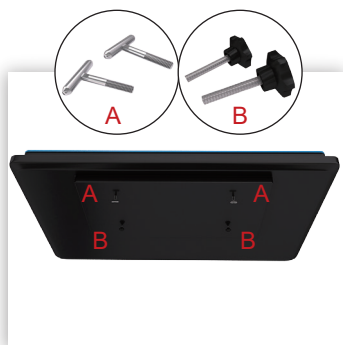

7. Use the bolts supplied and attach to the TV as you can see in the above images. Bolts(A) slide in to the hanging profile. Use wing nuts to secure TV profile.

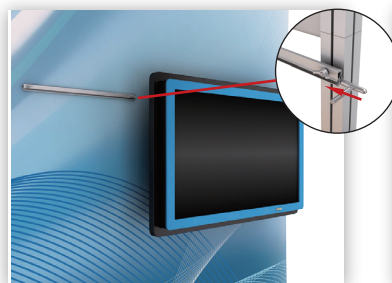

8. After you connect the TV unit you can cover the wires and the connections by using the supplied black fabric.

Standroid Setup Instructions



9. From the top of the joint insert the belt through the fabric making a hole, secure by (C)



10. Place the cable on the (C) via a hook on the end of the cable, and on the bottom use (D) to hook and tension, screw tension hook till the frame with the TV is 90°.

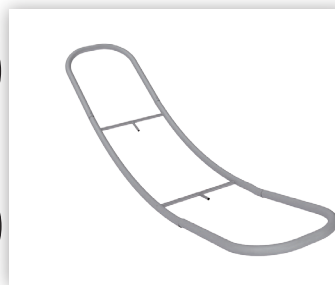

11. Assemble the header frame same shape as the above. Follow color code.



12. Put the frame in the header fabric and as you zip it, make sure the hanging small pipes come outside through the eyelets.

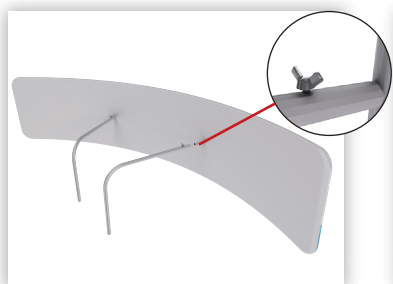

13. Slide the hanging post on to the header and tighten the bolts on to the small shaft.

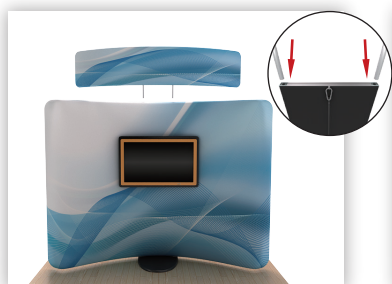

14. Lift header and place on top of the frame that is holding the TV unit.

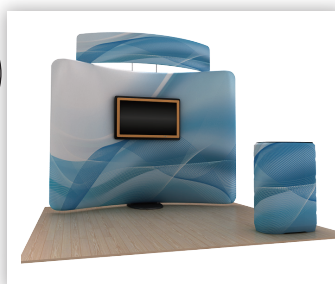

15. Enjoy!

